

Stock Bore V-pulleys

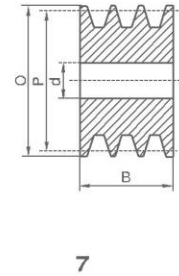
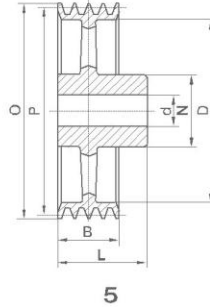
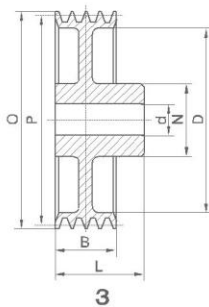

SPC-2

ITEM NO.	NO.OF GROOVES	O.D	PD	TYPE	N	L	D	E	B	d
SPC120-2S	2	129.6	120	7	—	—	—	—	59.5	15
SPC140-2S	2	149.6	140	7	—	—	—	—	59.5	20
SPC150-2S	2	159.6	150	7	—	—	—	—	59.5	20
SPC160-2S	2	169.6	160	7	—	—	—	—	59.5	20
SPC180-2S	2	189.6	180	3	80	60	123	16	59.5	20
SPC200-2S	2	209.6	200	3	80	60	143	16	59.5	20
SPC225-2S	2	234.6	225	3	88	60	168	18	59.5	20
SPC250-2S	2	259.6	250	3	92	60	193	18	59.5	20
SPC280-2S	2	289.6	280	3	92	60	223	18	59.5	20
SPC300-2S	2	309.6	300	3	92	60	243	18	59.5	20
SPC315-2S	2	324.6	315	5	92	60	258	18	59.5	20
SPC340-2S	2	349.6	340	5	100	60	283	18	59.5	20
SPC355-2S	2	364.6	355	5	110	60	298	18	59.5	25
SPC400-2S	2	409.6	400	5	110	70	343	20	59.5	25
SPC450-2S	2	459.6	450	5	110	70	393	20	59.5	25
SPC500-2S	2	509.6	500	5	114	70	443	20	59.5	25
SPC560-2S	2	569.6	560	5	114	70	503	24	59.5	25
SPC600-2S	2	609.6	600	5	114	70	543	24	59.5	25
SPC630-2S	2	639.6	630	5	114	70	573	24	59.5	25

Stock Bore V-pulleys

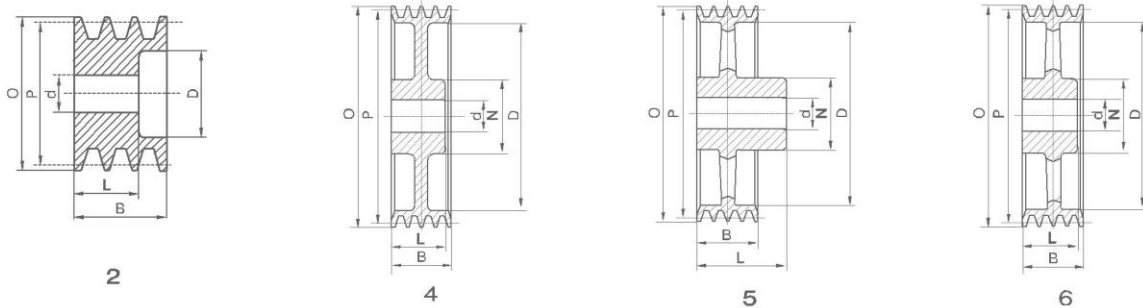

SPC-3

ITEM NO.	NO.OF GROOVES	O.D	PD	TYPE	N	L	D	E	B	d
SPC140-3S	3	149.6	140	2	—	65	83	—	85	20
SPC150-3S	3	159.6	150	2	—	65	93	—	85	20
SPC160-3S	3	169.6	160	2	—	65	103	—	85	20
SPC180-3S	3	189.6	180	4	82	65	123	18	85	20
SPC200-3S	3	209.6	200	4	86	65	143	18	85	20
SPC225-3S	3	234.6	225	4	90	70	168	21	85	20
SPC250-3S	3	259.6	250	4	92	70	193	21	85	20
SPC280-3S	3	289.6	280	4	92	70	223	21	85	20
SPC300-3S	3	309.6	300	4	92	70	243	21	85	20
SPC315-3S	3	324.6	315	6	92	70	258	22	85	25
SPC340-3S	3	349.6	340	6	100	70	283	22	85	25
SPC355-3S	3	364.6	355	6	110	70	298	22	85	25
SPC400-3S	3	409.6	400	5	114	90	343	24	85	25
SPC450-3S	3	459.6	450	5	114	90	393	24	85	25
SPC500-3S	3	509.6	500	5	114	90	443	24	85	25
SPC560-3S	3	569.6	560	5	114	90	503	28	85	25
SPC600-3S	3	609.6	600	5	114	90	543	28	85	25
SPC630-3S	3	639.6	630	5	114	90	573	28	85	25

Stock Bore V-pulleys

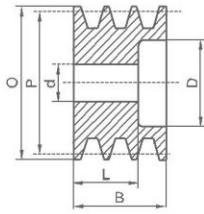

2

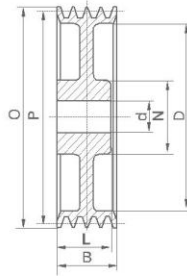

4

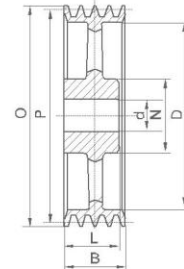

6

SPC-4

ITEM NO.	NO.OF GROOVES	O.D	PD	TYPE	N	L	D	E	B	d
SPC140-4S	4	149.6	140	2	—	80	83	—	110.5	20
SPC150-4S	4	159.6	150	2	—	80	93	—	110.5	20
SPC160-4S	4	169.6	160	2	—	80	103	—	110.5	20
SPC180-4S	4	189.6	180	4	82	80	123	20	110.5	20
SPC200-4S	4	209.6	200	4	90	90	143	25	110.5	20
SPC225-4S	4	234.6	225	4	90	90	168	25	110.5	25
SPC250-4S	4	259.6	250	4	100	90	193	25	110.5	25
SPC280-4S	4	289.6	280	4	100	90	223	25	110.5	25
SPC300-4S	4	309.6	300	4	100	90	243	25	110.5	25
SPC315-4S	4	324.6	315	4	110	90	258	25	110.5	25
SPC340-4S	4	349.6	340	6	114	90	283	25	110.5	25
SPC355-4S	4	364.6	355	6	114	90	298	25	110.5	25
SPC400-4S	4	409.6	400	6	114	90	343	26	110.5	25
SPC450-4S	4	459.6	450	6	120	90	393	28	110.5	25
SPC500-4S	4	509.6	500	6	126	90	443	28	110.5	25
SPC560-4S	4	569.6	560	6	130	90	503	30	110.5	25
SPC600-4S	4	609.6	600	6	130	90	543	30	110.5	25
SPC630-4S	4	639.6	630	6	130	90	573	30	110.5	25

Stock Bore V-pulleys

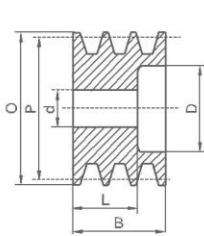

2

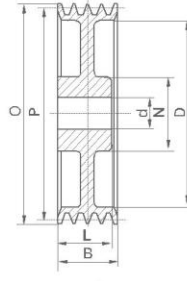

4

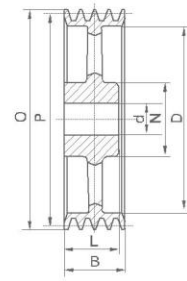

6

SPC-5

ITEM NO.	NO.OF GROOVES	O.D	P.D	TYPE	N	L	D	E	B	d
SPC150-5S	5	159.6	150	2	—	96	93	—	136	20
SPC160-5S	5	169.6	160	2	—	96	103	—	136	20
SPC180-5S	5	189.6	180	4	82	96	123	20	136	20
SPC200-5S	5	209.6	200	4	90	100	143	25	136	25
SPC225-5S	5	234.6	225	4	90	100	168	25	136	25
SPC250-5S	5	259.6	250	4	102	100	193	25	136	25
SPC280-5S	5	289.6	280	4	102	100	223	25	136	25
SPC300-5S	5	309.6	300	4	104	100	243	25	136	25
SPC315-5S	5	324.6	315	4	112	100	258	25	136	25
SPC340-5S	5	349.6	340	6	114	100	283	28	136	25
SPC355-5S	5	364.6	355	6	114	100	298	28	136	25
SPC400-5S	5	409.6	400	6	120	100	343	28	136	25
SPC450-5S	5	459.6	450	6	120	100	393	30	136	25
SPC500-5S	5	509.6	500	6	126	100	443	30	136	25
SPC560-5S	5	569.6	560	6	130	100	503	32	136	25
SPC600-5S	5	609.6	600	6	130	100	543	32	136	25
SPC630-5S	5	639.6	630	6	130	100	573	32	136	25