

## Taper Bore V-pulleys

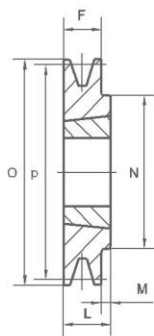

TYPE1

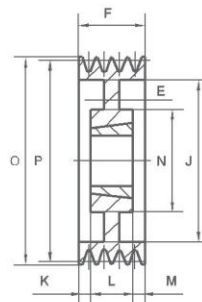

TYPE6

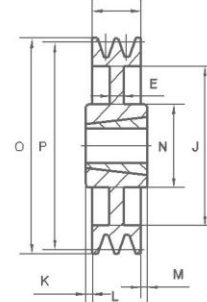

TYPE7

## SPB-1

| ITEM NO.  | NO.OF GROOVES | PD    | O.D   | TYPE | BUSH NO. | MAX BORE | E  | F  | J   | K   | L  | M   | N   |
|-----------|---------------|-------|-------|------|----------|----------|----|----|-----|-----|----|-----|-----|
| SPB100-01 | 1             | 100.0 | 107.0 | 1    | 1610     | 42       | —  | 25 | —   | —   | 25 | —   | —   |
| SPB112-01 | 1             | 112.0 | 119.0 | 1    | 1610     | 42       | —  | 25 | —   | —   | 25 | —   | —   |
| SPB118-01 | 1             | 118.0 | 125.0 | 1    | 1610     | 42       | —  | 25 | —   | —   | 25 | —   | —   |
| SPB125-01 | 1             | 125.0 | 132.0 | 1    | 1610     | 42       | —  | 25 | —   | —   | 25 | —   | —   |
| SPB132-01 | 1             | 132.0 | 139.0 | 1    | 1610     | 42       | —  | 25 | —   | —   | 25 | —   | —   |
| SPB140-01 | 1             | 140.0 | 147.0 | 1    | 1610     | 42       | —  | 25 | —   | —   | 25 | —   | —   |
| SPB150-01 | 1             | 150.0 | 157.0 | 1    | 1610     | 42       | —  | 25 | —   | —   | 25 | —   | —   |
| SPB160-01 | 1             | 160.0 | 167.0 | 1    | 1610     | 42       | —  | 25 | —   | —   | 25 | —   | —   |
| SPB170-01 | 1             | 170.0 | 177.0 | 1    | 1610     | 42       | —  | 25 | —   | —   | 25 | —   | —   |
| SPB180-01 | 1             | 180.0 | 187.0 | 6    | 1610     | 42       | 10 | 25 | 137 | —   | 25 | —   | 80  |
| SPB190-01 | 1             | 190.0 | 197.0 | 7    | 2012     | 50       | 10 | 25 | 147 | 3.5 | 32 | 3.5 | 100 |
| SPB200-01 | 1             | 200.0 | 207.0 | 7    | 2012     | 50       | 10 | 25 | 157 | 3.5 | 32 | 3.5 | 100 |
| SPB212-01 | 1             | 212.0 | 219.0 | 7    | 2012     | 50       | 10 | 25 | 169 | 3.5 | 32 | 3.5 | 100 |
| SPB224-01 | 1             | 224.0 | 231.0 | 7    | 2012     | 50       | 10 | 25 | 181 | 3.5 | 32 | 3.5 | 100 |
| SPB236-01 | 1             | 236.0 | 243.0 | 7    | 2012     | 50       | 10 | 25 | 193 | 3.5 | 32 | 3.5 | 100 |
| SPB250-01 | 1             | 250.0 | 257.0 | 7    | 2012     | 50       | 10 | 25 | 207 | 3.5 | 32 | 3.5 | 100 |
| SPB280-01 | 1             | 280.0 | 287.0 | 7    | 2012     | 50       | 10 | 25 | 237 | 3.5 | 32 | 3.5 | 100 |
| SPB315-01 | 1             | 315.0 | 322.0 | 7    | 2012     | 50       | 10 | 25 | 272 | 3.5 | 32 | 3.5 | 100 |

### Standard bore dimensions of taper bore bushes

| Bushing | Stock Bores |    |    |    |    |    |    |    |    |    |    |    |    |    |    |    |    |    |    |    |    |    |   |
|---------|-------------|----|----|----|----|----|----|----|----|----|----|----|----|----|----|----|----|----|----|----|----|----|---|
|         | 11          | 12 | 14 | 16 | 18 | 19 | 20 | 22 | 24 | 25 | 28 | 30 | 32 | 35 | 38 | 40 | 42 | 45 | 48 | 50 | 55 | 60 |   |
| 1210    | ●           | ●  | ●  | ●  | ●  | ●  | ●  | ●  | ●  | ●  | ●  | ●  | ●  |    |    |    |    |    |    |    |    |    |   |
| 1610    |             |    | ●  | ●  | ●  | ●  | ●  | ●  | ●  | ●  | ●  | ●  | ●  | ●  | ●  | ▲  |    |    |    |    |    |    |   |
| 2012    |             |    |    |    | ●  | ●  | ●  | ●  | ●  | ●  | ●  | ●  | ●  | ●  | ●  | ●  | ●  | ●  | ●  | ●  | ●  | ●  | ● |
| 2517    |             |    |    |    |    | ●  | ●  | ●  | ●  | ●  | ●  | ●  | ●  | ●  | ●  | ●  | ●  | ●  | ●  | ●  | ●  | ●  | ● |

▲ shallow keyway

## Taper Bore V-pulleys

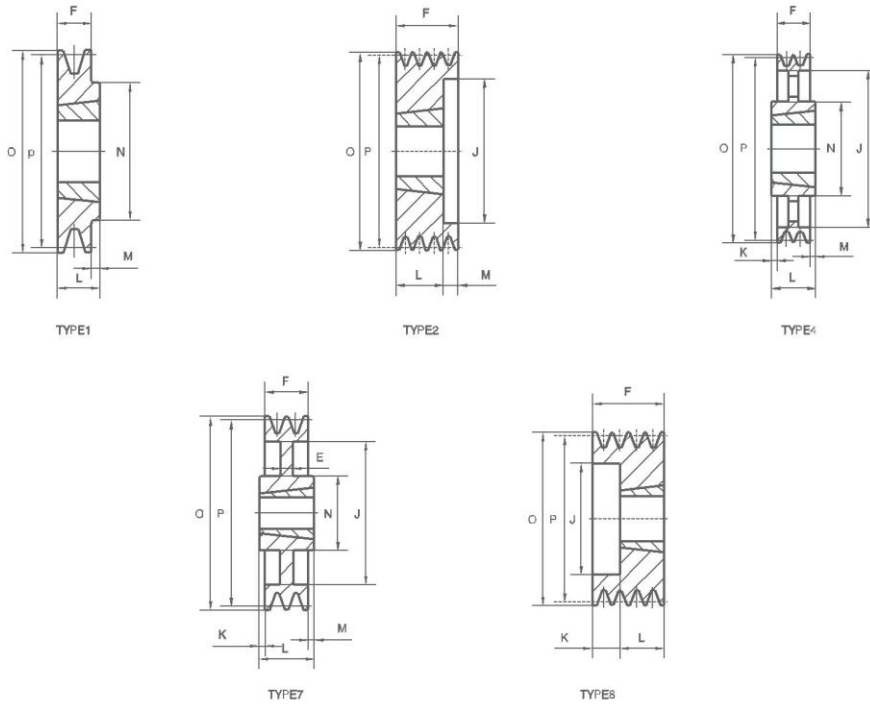

## SPB-2

| ITEM NO.  | NO.OF GROOVES | PD    | O.D   | TYPE | BUSH NO. | MAX BORE | E  | F  | J   | K   | L  | M   | N   |
|-----------|---------------|-------|-------|------|----------|----------|----|----|-----|-----|----|-----|-----|
| SPB100-02 | 2             | 100.0 | 107.0 | 8    | 1610     | 42       | —  | 44 | 62  | —   | 25 | 19  | —   |
| SPB112-02 | 2             | 112.0 | 119.0 | 2    | 1610     | 42       | —  | 44 | 72  | —   | 25 | 19  | —   |
| SPB118-02 | 2             | 118.0 | 127.0 | 2    | 1610     | 42       | —  | 44 | 78  | —   | 25 | 19  | —   |
| SPB125-02 | 2             | 125.0 | 132.0 | 2    | 2012     | 50       | —  | 44 | 82  | —   | 32 | 12  | —   |
| SPB132-02 | 2             | 132.0 | 139.0 | 2    | 2012     | 50       | —  | 44 | 89  | —   | 32 | 12  | —   |
| SPB140-02 | 2             | 140.0 | 147.0 | 2    | 2012     | 50       | —  | 44 | 97  | —   | 32 | 12  | —   |
| SPB150-02 | 2             | 150.0 | 157.0 | 2    | 2012     | 50       | —  | 44 | 107 | —   | 32 | 12  | —   |
| SPB160-02 | 2             | 160.0 | 167.0 | 2    | 2012     | 50       | —  | 44 | 117 | —   | 32 | 12  | —   |
| SPB170-02 | 2             | 170.0 | 177.0 | 2    | 2012     | 50       | —  | 44 | 127 | —   | 32 | 12  | —   |
| SPB180-02 | 2             | 180.0 | 187.0 | 1    | 2517     | 60       | —  | 44 | —   | —   | 45 | 1   | 120 |
| SPB190-02 | 2             | 190.0 | 197.0 | 1    | 2517     | 60       | —  | 44 | —   | —   | 45 | 1   | 120 |
| SPB200-02 | 2             | 200.0 | 207.0 | 1    | 2517     | 60       | —  | 44 | —   | —   | 45 | 1   | 120 |
| SPB212-02 | 2             | 212.0 | 219.0 | 7    | 2517     | 60       | 10 | 44 | 169 | —   | 45 | 1   | 120 |
| SPB224-02 | 2             | 224.0 | 231.0 | 7    | 2517     | 60       | 10 | 44 | 181 | 1   | 45 | —   | 120 |
| SPB236-02 | 2             | 236.0 | 243.0 | 7    | 2517     | 60       | 10 | 44 | 193 | 1   | 45 | —   | 120 |
| SPB250-02 | 2             | 250.0 | 257.0 | 7    | 2517     | 60       | 10 | 44 | 207 | 1   | 45 | —   | 120 |
| SPB280-02 | 2             | 280.0 | 287.0 | 7    | 2517     | 60       | 12 | 44 | 237 | 1   | 45 | —   | 120 |
| SPB300-02 | 2             | 300.0 | 307.0 | 7    | 2517     | 60       | 12 | 44 | 257 | 1   | 45 | —   | 120 |
| SPB315-02 | 2             | 315.0 | 322.0 | 7    | 2517     | 60       | 12 | 44 | 272 | 1   | 45 | —   | 120 |
| SPB335-02 | 2             | 335.0 | 342   | 7    | 2517     | 60       | 12 | 44 | 292 | 1   | 45 | —   | 120 |
| SPB355-02 | 2             | 355.0 | 362.0 | 4    | 3020     | 75       | —  | 44 | 312 | 3.5 | 51 | 3.5 | 150 |
| SPB400-02 | 2             | 400.0 | 407.0 | 4    | 3020     | 75       | —  | 44 | 357 | 3.5 | 51 | 3.5 | 150 |
| SPB450-02 | 2             | 450.0 | 457.0 | 4    | 3020     | 75       | —  | 44 | 407 | 3.5 | 51 | 3.5 | 150 |
| SPB500-02 | 2             | 500.0 | 507.0 | 4    | 3020     | 75       | —  | 44 | 457 | 3.5 | 51 | 3.5 | 150 |
| SPB560-02 | 2             | 560.0 | 567.0 | 4    | 3030     | 75       | —  | 44 | 517 | 4   | 76 | 28  | 150 |
| SPB630-02 | 2             | 630.0 | 637.0 | 4    | 3030     | 75       | —  | 44 | 587 | 4   | 76 | 28  | 150 |

## Taper Bore V-pulleys

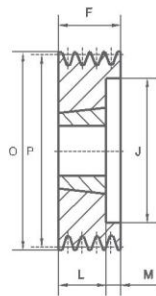

TYPE2

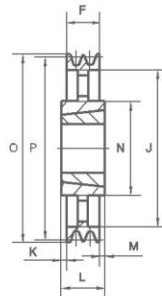

TYPE4

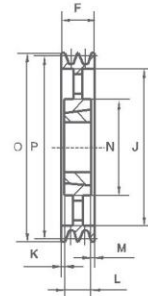

TYPE5

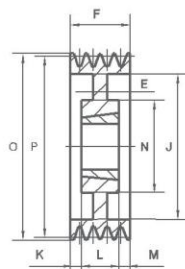

TYPE6

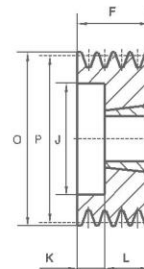

TYPE8

# SPB-3

| ITEM NO.   | NO.OF GROOVES | PD     | O.D    | TYPE | BUSH NO. | MAX BORE | E  | F  | J    | K  | L   | M  | N   |
|------------|---------------|--------|--------|------|----------|----------|----|----|------|----|-----|----|-----|
| SPB100-03  | 3             | 100.0  | 107.0  | 8    | 1610     | 42       | —  | 63 | 57   | —  | 25  | 38 | —   |
| SPB112-03  | 3             | 112.0  | 119.0  | 2    | 1610     | 42       | —  | 63 | 72   | —  | 25  | 38 | —   |
| SPB118-03  | 3             | 118.0  | 125.0  | 2    | 1610     | 42       | —  | 63 | 78   | —  | 25  | 38 | —   |
| SPB125-03  | 3             | 125.0  | 132.0  | 2    | 2012     | 50       | —  | 63 | 82   | —  | 32  | 31 | —   |
| SPB132-03  | 3             | 132.0  | 139.0  | 2    | 2012     | 50       | —  | 63 | 89   | —  | 32  | 31 | —   |
| SPB140-03  | 3             | 140.0  | 147.0  | 2    | 2012     | 50       | —  | 63 | 97   | —  | 32  | 31 | —   |
| SPB150-03  | 3             | 150.0  | 157.0  | 2    | 2517     | 60       | —  | 63 | 107  | —  | 45  | 18 | —   |
| SPB160-03  | 3             | 160.0  | 167.0  | 2    | 2517     | 60       | —  | 63 | 117  | —  | 45  | 18 | —   |
| SPB170-03  | 3             | 170.0  | 177.0  | 2    | 2517     | 60       | —  | 63 | 127  | —  | 45  | 18 | —   |
| SPB180-03  | 3             | 180.0  | 187.0  | 2    | 2517     | 60       | —  | 63 | 137  | —  | 45  | 18 | —   |
| SPB190-03  | 3             | 190.0  | 197.0  | 2    | 2517     | 60       | —  | 63 | 147  | —  | 45  | 18 | —   |
| SPB200-03  | 3             | 200.0  | 207.0  | 2    | 2517     | 60       | —  | 63 | 157  | —  | 45  | 18 | —   |
| SPB212-03  | 3             | 212.0  | 219.0  | 6    | 2517     | 60       | 12 | 63 | 169  | —  | 45  | 18 | 120 |
| SPB224-03  | 3             | 224.0  | 231.0  | 6    | 2517     | 60       | 12 | 63 | 181  | —  | 45  | 18 | 120 |
| SPB236-03  | 3             | 236.0  | 243.0  | 6    | 2517     | 60       | 10 | 63 | 193  | —  | 45  | 18 | 120 |
| SPB250-03  | 3             | 250.0  | 257.0  | 6    | 3020     | 75       | 12 | 63 | 207  | —  | 51  | 12 | 150 |
| SPB280-03  | 3             | 280.0  | 287.0  | 6    | 3020     | 75       | 13 | 63 | 237  | 6  | 51  | 6  | 150 |
| SPB300-03  | 3             | 300.0  | 307.0  | 6    | 3020     | 75       | 13 | 63 | 257  | 6  | 51  | 6  | 150 |
| SPB315-03  | 3             | 315.0  | 322.0  | 6    | 3020     | 75       | 13 | 63 | 272  | 6  | 51  | 6  | 150 |
| SPB335-03  | 3             | 335.0  | 342.0  | 6    | 3020     | 75       | 13 | 63 | 292  | 6  | 51  | 6  | 150 |
| SPB355-03  | 3             | 355.0  | 362.0  | 5    | 3020     | 75       | —  | 63 | 312  | 6  | 51  | 6  | 150 |
| SPB400-03  | 3             | 400.0  | 407.0  | 4    | 3535     | 90       | —  | 63 | 357  | 13 | 89  | 13 | 170 |
| SPB450-03  | 3             | 450.0  | 457.0  | 4    | 3535     | 90       | —  | 63 | 407  | —  | 89  | 26 | 170 |
| SPB500-03  | 3             | 500.0  | 507.0  | 4    | 3535     | 90       | —  | 63 | 457  | —  | 89  | 26 | 170 |
| SPB560-03  | 3             | 560.0  | 567.0  | 4    | 3535     | 90       | —  | 63 | 517  | —  | 89  | 26 | 170 |
| SPB630-03  | 3             | 630.0  | 637.0  | 4    | 3535     | 90       | —  | 63 | 587  | —  | 89  | 26 | 170 |
| SPB710-03  | 3             | 710.0  | 717.0  | 4    | 3535     | 90       | —  | 63 | 664  | 4  | 89  | 22 | 170 |
| SPB800-03  | 3             | 800.0  | 807.0  | 4    | 3535     | 90       | —  | 63 | 754  | 4  | 89  | 22 | 170 |
| SPB900-03  | 3             | 900.0  | 907.0  | 4    | 3535     | 90       | —  | 63 | 854  | 4  | 89  | 22 | 170 |
| SPB1000-03 | 3             | 1000.0 | 1007.0 | 4    | 4040     | 100      | —  | 63 | 954  | 6  | 102 | 33 | 200 |
| SPB1250-03 | 3             | 1250.0 | 1257.0 | 4    | 4040     | 100      | —  | 63 | 1204 | 6  | 102 | 33 | 200 |

## Taper Bore V-pulleys

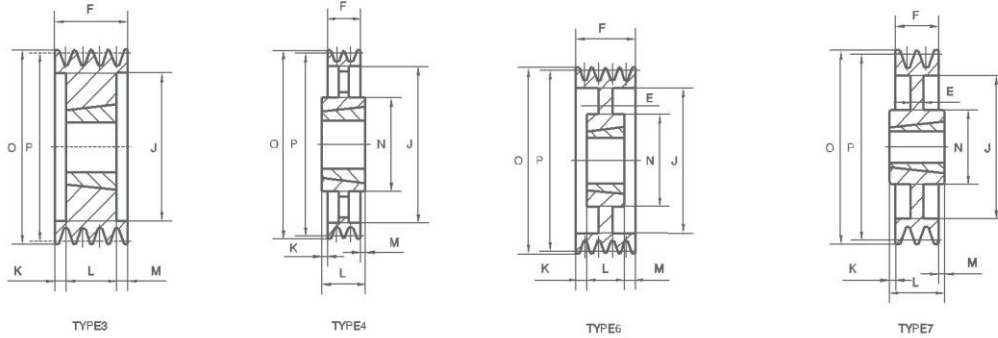

## SPB-4

| ITEM NO.   | NO.OF GROOVES | P.D    | O.D    | TYPE | BUSH NO. | MAX BORE | E  | F  | J    | K    | L   | M    | N   |
|------------|---------------|--------|--------|------|----------|----------|----|----|------|------|-----|------|-----|
| SPB125-04  | 4             | 125.0  | 132.0  | 3    | 2012     | 50       | —  | 82 | 82   | 25   | 32  | 25   | —   |
| SPB132-04  | 4             | 132.0  | 139.0  | 3    | 2012     | 50       | —  | 82 | 89   | 25   | 32  | 25   | —   |
| SPB140-04  | 4             | 140.0  | 147.0  | 3    | 2517     | 60       | —  | 82 | 97   | 18.5 | 45  | 18.5 | —   |
| SPB150-04  | 4             | 150.0  | 157.0  | 3    | 2517     | 60       | —  | 82 | 107  | 18.5 | 45  | 18.5 | —   |
| SPB160-04  | 4             | 160.0  | 167.0  | 3    | 2517     | 60       | —  | 82 | 117  | 18.5 | 45  | 18.5 | —   |
| SPB170-04  | 4             | 170.0  | 177.0  | 3    | 2517     | 60       | —  | 82 | 127  | 18.5 | 45  | 18.5 | —   |
| SPB180-04  | 4             | 180.0  | 187.0  | 3    | 2517     | 60       | —  | 82 | 137  | 18.5 | 45  | 18.5 | —   |
| SPB190-04  | 4             | 190.0  | 197.0  | 3    | 2517     | 60       | —  | 82 | 147  | 18.5 | 45  | 18.5 | —   |
| SPB200-04  | 4             | 200.0  | 207.0  | 3    | 3020     | 75       | —  | 82 | 157  | 15.5 | 51  | 15.5 | —   |
| SPB212-04  | 4             | 212.0  | 219.0  | 3    | 3020     | 75       | —  | 82 | 169  | 15.5 | 51  | 15.5 | —   |
| SPB224-04  | 4             | 224.0  | 231.0  | 3    | 3020     | 75       | —  | 82 | 181  | 15.5 | 51  | 15.5 | —   |
| SPB236-04  | 4             | 236.0  | 243.0  | 3    | 3020     | 75       | —  | 82 | 193  | 15.5 | 51  | 15.5 | —   |
| SPB250-04  | 4             | 250.0  | 257.0  | 6    | 3020     | 75       | 14 | 82 | 207  | 15.5 | 51  | 15.5 | 150 |
| SPB280-04  | 4             | 280.0  | 287.0  | 6    | 3020     | 75       | 16 | 82 | 237  | 15.5 | 51  | 15.5 | 150 |
| SPB300-04  | 4             | 300.0  | 307.0  | 6    | 3020     | 75       | 16 | 82 | 257  | 15.5 | 51  | 15.5 | 150 |
| SPB315-04  | 4             | 315.0  | 322.0  | 7    | 3535     | 90       | 16 | 82 | 272  | 3.5  | 89  | 3.5  | 170 |
| SPB335-04  | 4             | 335.0  | 342.0  | 7    | 3535     | 90       | 16 | 82 | 292  | 3.5  | 89  | 3.5  | 170 |
| SPB355-04  | 4             | 355.0  | 362.0  | 7    | 3535     | 90       | 16 | 82 | 312  | 3.5  | 89  | 3.5  | 170 |
| SPB400-04  | 4             | 400.0  | 407.0  | 4    | 3535     | 90       | —  | 82 | 357  | 3.5  | 89  | 3.5  | 170 |
| SPB450-04  | 4             | 450.0  | 457.0  | 4    | 3535     | 90       | —  | 82 | 407  | —    | 89  | 7    | 170 |
| SPB500-04  | 4             | 500.0  | 507.0  | 4    | 3535     | 90       | —  | 82 | 457  | —    | 89  | 7    | 170 |
| SPB560-04  | 4             | 560.0  | 567.0  | 4    | 3535     | 90       | —  | 82 | 517  | —    | 89  | 7    | 170 |
| SPB630-04  | 4             | 630.0  | 637.0  | 4    | 3535     | 90       | —  | 82 | 587  | —    | 89  | 7    | 170 |
| SPB710-04  | 4             | 710.0  | 717.0  | 4    | 3535     | 90       | —  | 82 | 664  | 3.5  | 89  | 3.5  | 187 |
| SPB800-04  | 4             | 800.0  | 807.0  | 4    | 4040     | 100      | —  | 82 | 754  | 4    | 102 | 16   | 200 |
| SPB900-04  | 4             | 900.0  | 907.0  | 4    | 4040     | 100      | —  | 82 | 854  | 4    | 102 | 16   | 216 |
| SPB1000-04 | 4             | 1000.0 | 1007.0 | 4    | 4040     | 100      | —  | 82 | 954  | 4    | 102 | 16   | 216 |
| SPB1250-04 | 4             | 1250.0 | 1257.0 | 4    | 4545     | 110      | —  | 82 | 1204 | 6    | 114 | 26   | 225 |

## Taper Bore V-pulleys

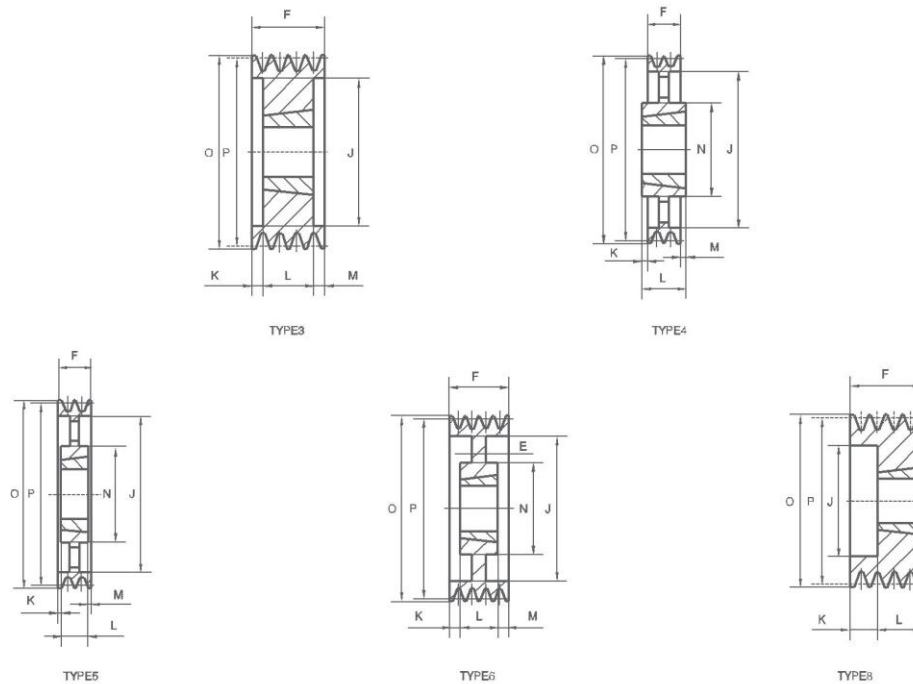

## SPB-5

| ITEM NO.   | NO.OF GROOVES | P.D    | O.D    | TYPE | BUSH NO. | MAX BORE | E  | F   | J    | K   | L   | M   | N   |
|------------|---------------|--------|--------|------|----------|----------|----|-----|------|-----|-----|-----|-----|
| SPB125-05  | 5             | 125.0  | 132.0  | 8    | 2012     | 50       | —  | 101 | 82   | 69  | 32  | —   | —   |
| SPB132-05  | 5             | 132.0  | 139.0  | 8    | 2517     | 60       | —  | 101 | 89   | 56  | 45  | —   | —   |
| SPB140-05  | 5             | 140.0  | 147.0  | 3    | 2517     | 60       | —  | 101 | 97   | 28  | 45  | 28  | —   |
| SPB150-05  | 5             | 150.0  | 157.0  | 3    | 2517     | 60       | —  | 101 | 107  | 28  | 45  | 28  | —   |
| SPB160-05  | 5             | 160.0  | 167.0  | 3    | 2517     | 60       | —  | 101 | 117  | 28  | 45  | 28  | —   |
| SPB170-05  | 5             | 170.0  | 177.0  | 3    | 3020     | 75       | —  | 101 | 127  | 25  | 51  | 25  | —   |
| SPB180-05  | 5             | 180.0  | 187.0  | 3    | 3020     | 75       | —  | 101 | 137  | 25  | 51  | 25  | —   |
| SPB190-05  | 5             | 190.0  | 197.0  | 3    | 3020     | 75       | —  | 101 | 147  | 25  | 51  | 25  | —   |
| SPB200-05  | 5             | 200.0  | 207.0  | 3    | 3020     | 75       | —  | 101 | 157  | 25  | 51  | 25  | —   |
| SPB212-05  | 5             | 212.0  | 219.0  | 3    | 3020     | 75       | —  | 101 | 169  | 25  | 51  | 25  | —   |
| SPB224-05  | 5             | 224.0  | 231.0  | 3    | 3020     | 75       | —  | 101 | 181  | 25  | 51  | 25  | —   |
| SPB236-05  | 5             | 236.0  | 243.0  | 3    | 3535     | 90       | —  | 101 | 193  | 6   | 89  | 6   | —   |
| SPB250-05  | 5             | 250.0  | 257.0  | 3    | 3535     | 90       | —  | 101 | 207  | 6   | 89  | 6   | —   |
| SPB280-05  | 5             | 280.0  | 287.0  | 6    | 3535     | 90       | 18 | 101 | 237  | 6   | 89  | 6   | 170 |
| SPB300-05  | 5             | 300.0  | 307.0  | 6    | 3535     | 90       | 18 | 101 | 257  | 6   | 89  | 6   | 170 |
| SPB315-05  | 5             | 315.0  | 322.0  | 6    | 3535     | 90       | 18 | 101 | 272  | 6   | 89  | 6   | 170 |
| SPB335-05  | 5             | 335.0  | 342.0  | 6    | 3535     | 90       | 16 | 101 | 292  | 6   | 89  | 6   | 170 |
| SPB355-05  | 5             | 355.0  | 362.0  | 5    | 3535     | 90       | —  | 101 | 312  | 6   | 89  | 6   | 170 |
| SPB400-05  | 5             | 400.0  | 407.0  | 5    | 3535     | 90       | —  | 101 | 357  | 6   | 89  | 6   | 170 |
| SPB450-05  | 5             | 450.0  | 457.0  | 5    | 3535     | 90       | —  | 101 | 407  | —   | 89  | 12  | 170 |
| SPB500-05  | 5             | 500.0  | 507.0  | 5    | 3535     | 90       | —  | 101 | 457  | —   | 89  | 12  | 170 |
| SPB560-05  | 5             | 560.0  | 567.0  | 4    | 4040     | 100      | —  | 101 | 517  | —   | 102 | 1   | 200 |
| SPB630-05  | 5             | 630.0  | 637.0  | 4    | 4040     | 100      | —  | 101 | 587  | —   | 102 | 1   | 200 |
| SPB710-05  | 5             | 710.0  | 717.0  | 4    | 4040     | 100      | —  | 101 | 664  | 0.5 | 102 | 0.5 | 200 |
| SPB800-05  | 5             | 800.0  | 807.0  | 4    | 4040     | 100      | —  | 101 | 754  | 0.5 | 102 | 0.5 | 200 |
| SPB900-05  | 5             | 900.0  | 907.0  | 4    | 4545     | 110      | —  | 101 | 854  | 6.5 | 114 | 6.5 | 225 |
| SPB1000-05 | 5             | 1000.0 | 1007.0 | 4    | 4545     | 110      | —  | 101 | 954  | 6.5 | 114 | 6.5 | 225 |
| SPB1250-05 | 5             | 1250.0 | 1257.0 | 4    | 4545     | 110      | —  | 101 | 1204 | 6.5 | 114 | 6.5 | 225 |

## Taper Bore V-pulleys

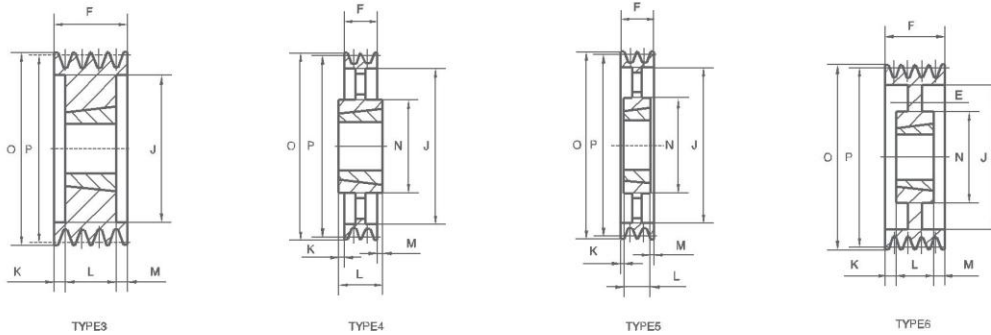

## SPB-6

| ITEM NO.   | NO.OF GROOVES | PD     | O.D    | TYPE | BUSH NO. | MAX BORE | E  | F   | J    | K    | L   | M    | N   |
|------------|---------------|--------|--------|------|----------|----------|----|-----|------|------|-----|------|-----|
| SPB140-06  | 6             | 140.0  | 147.0  | 3    | 2517     | 60       | —  | 120 | 97   | 37.5 | 45  | 37.5 | —   |
| SPB150-06  | 6             | 150.0  | 157.0  | 3    | 2517     | 60       | —  | 120 | 107  | 37.5 | 45  | 37.5 | —   |
| SPB160-06  | 6             | 160.0  | 167.0  | 3    | 3020     | 75       | —  | 120 | 117  | 34.5 | 51  | 34.5 | —   |
| SPB170-06  | 6             | 170.0  | 177.0  | 3    | 3020     | 75       | —  | 120 | 127  | 34.5 | 51  | 34.5 | —   |
| SPB180-06  | 6             | 180.0  | 187.0  | 3    | 3020     | 75       | —  | 120 | 137  | 34.5 | 51  | 34.5 | —   |
| SPB190-06  | 6             | 190.0  | 197.0  | 3    | 3020     | 75       | —  | 120 | 147  | 34.5 | 51  | 34.5 | —   |
| SPB200-06  | 6             | 200.0  | 207.0  | 3    | 3020     | 75       | —  | 120 | 157  | 34.5 | 51  | 34.5 | —   |
| SPB212-06  | 6             | 212.0  | 219.0  | 3    | 3535     | 90       | —  | 120 | 169  | 15.5 | 89  | 15.5 | —   |
| SPB224-06  | 6             | 224.0  | 231.0  | 3    | 3535     | 90       | —  | 120 | 181  | 15.5 | 89  | 15.5 | —   |
| SPB236-06  | 6             | 236.0  | 243.0  | 3    | 3535     | 90       | —  | 120 | 193  | 15.5 | 89  | 15.5 | —   |
| SPB250-06  | 6             | 250.0  | 257.0  | 3    | 3535     | 90       | —  | 120 | 207  | 15.5 | 89  | 15.5 | —   |
| SPB280-06  | 6             | 280.0  | 287.0  | 6    | 3535     | 90       | 18 | 120 | 237  | 15.5 | 89  | 15.5 | 170 |
| SPB300-06  | 6             | 300.0  | 307.0  | 6    | 3535     | 90       | 18 | 120 | 257  | 15.5 | 89  | 15.5 | 170 |
| SPB315-06  | 6             | 315.0  | 322.0  | 6    | 3535     | 90       | 18 | 120 | 272  | 15.5 | 89  | 15.5 | 170 |
| SPB335-06  | 6             | 335.0  | 342.0  | 6    | 3535     | 90       | 18 | 120 | 292  | 15.5 | 89  | 15.5 | 170 |
| SPB355-06  | 6             | 355.0  | 362.0  | 6    | 3535     | 90       | 18 | 120 | 312  | 15.5 | 89  | 15.5 | 170 |
| SPB400-06  | 6             | 400.0  | 407.0  | 5    | 3535     | 90       | —  | 120 | 357  | 15.5 | 89  | 15.5 | 170 |
| SPB450-06  | 6             | 450.0  | 457.0  | 5    | 4040     | 100      | —  | 120 | 407  | —    | 102 | 18   | 200 |
| SPB500-06  | 6             | 500.0  | 507.0  | 5    | 4040     | 100      | —  | 120 | 457  | —    | 102 | 18   | 200 |
| SPB560-06  | 6             | 560.0  | 567.0  | 5    | 4040     | 100      | —  | 120 | 517  | —    | 102 | 18   | 200 |
| SPB630-06  | 6             | 630.0  | 637.0  | 5    | 4040     | 100      | —  | 120 | 587  | —    | 102 | 18   | 200 |
| SPB710-06  | 6             | 710.0  | 717.0  | 5    | 4040     | 100      | —  | 120 | 664  | 9    | 102 | 9    | 216 |
| SPB800-06  | 6             | 800.0  | 807.0  | 5    | 4545     | 110      | —  | 120 | 754  | 3    | 114 | 3    | 225 |
| SPB900-06  | 6             | 900.0  | 907.0  | 5    | 4545     | 110      | —  | 120 | 854  | 3    | 114 | 3    | 225 |
| SPB1000-06 | 6             | 1000.0 | 1007.0 | 5    | 4545     | 110      | —  | 120 | 954  | 3    | 114 | 3    | 225 |
| SPB1250-06 | 6             | 1250.0 | 1257.0 | 4    | 5050     | 125      | —  | 120 | 1204 | 3.5  | 127 | 3.5  | 245 |

## Taper Bore V-pulleys

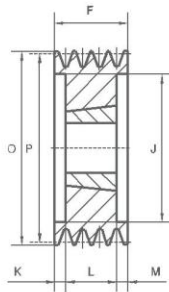

TYPE3

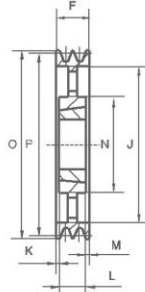

TYPE5

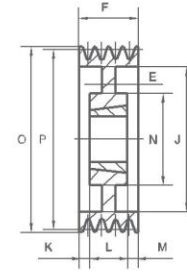

TYPE6

## SPB-8

| ITEM NO.   | NO.OF GROOVES | PD     | O.D    | TYPE | BUSH NO. | MAX BORE | E  | F   | J    | K    | L   | M    | N   |
|------------|---------------|--------|--------|------|----------|----------|----|-----|------|------|-----|------|-----|
| SPB160-08  | 8             | 160.0  | 167.0  | 3    | 3020     | 75       | —  | 158 | 117  | 53.5 | 51  | 53.5 | —   |
| SPB170-08  | 8             | 170.0  | 177.0  | 3    | 3030     | 75       | —  | 158 | 127  | 41   | 76  | 41   | —   |
| SPB180-08  | 8             | 180.0  | 187.0  | 3    | 3030     | 75       | —  | 158 | 137  | 41   | 76  | 41   | —   |
| SPB190-08  | 8             | 190.0  | 197.0  | 3    | 3030     | 75       | —  | 158 | 147  | 41   | 76  | 41   | —   |
| SPB200-08  | 8             | 200.0  | 207.0  | 3    | 3535     | 90       | —  | 158 | 157  | 34.5 | 89  | 34.5 | —   |
| SPB212-08  | 8             | 212.0  | 219.0  | 3    | 3535     | 90       | —  | 158 | 169  | 34.5 | 89  | 34.5 | —   |
| SPB224-08  | 8             | 224.0  | 231.0  | 3    | 3535     | 90       | —  | 158 | 181  | 34.5 | 89  | 34.5 | —   |
| SPB236-08  | 8             | 236.0  | 243.0  | 3    | 3535     | 90       | —  | 158 | 193  | 34.5 | 89  | 34.5 | —   |
| SPB250-08  | 8             | 250.0  | 257.0  | 3    | 3535     | 90       | —  | 158 | 207  | 34.5 | 89  | 34.5 | —   |
| SPB280-08  | 8             | 280.0  | 287.0  | 3    | 3535     | 90       | —  | 158 | 237  | 34.5 | 89  | 34.5 | —   |
| SPB300-08  | 8             | 300.0  | 307.0  | 6    | 3535     | 90       | 20 | 158 | 257  | 34.5 | 89  | 34.5 | 170 |
| SPB315-08  | 8             | 315.0  | 322.0  | 6    | 3535     | 90       | 18 | 158 | 272  | 34.5 | 89  | 34.5 | 170 |
| SPB335-08  | 8             | 335.0  | 342.0  | 6    | 3535     | 90       | 18 | 158 | 292  | 34.5 | 89  | 34.5 | 170 |
| SPB355-08  | 8             | 355.0  | 362.0  | 6    | 3535     | 90       | 18 | 158 | 312  | 34.5 | 89  | 34.5 | 170 |
| SPB400-08  | 8             | 400.0  | 407.0  | 5    | 4040     | 100      | —  | 158 | 357  | 28   | 102 | 28   | 200 |
| SPB450-08  | 8             | 450.0  | 457.0  | 5    | 4040     | 100      | —  | 158 | 407  | 28   | 102 | 28   | 200 |
| SPB500-08  | 8             | 500.0  | 507.0  | 5    | 4040     | 100      | —  | 158 | 457  | 28   | 102 | 28   | 200 |
| SPB560-08  | 8             | 560.0  | 567.0  | 5    | 4545     | 110      | —  | 158 | 517  | 22   | 114 | 22   | 225 |
| SPB630-08  | 8             | 630.0  | 637.0  | 5    | 4545     | 110      | —  | 158 | 587  | 22   | 114 | 22   | 225 |
| SPB710-08  | 8             | 710.0  | 717.0  | 5    | 4545     | 110      | —  | 158 | 664  | 22   | 114 | 22   | 225 |
| SPB800-08  | 8             | 800.0  | 807.0  | 5    | 4545     | 110      | —  | 158 | 754  | 22   | 114 | 22   | 225 |
| SPB900-08  | 8             | 900.0  | 907.0  | 5    | 4545     | 110      | —  | 158 | 854  | 22   | 114 | 22   | 225 |
| SPB1000-08 | 8             | 1000.0 | 1007.0 | 5    | 5050     | 125      | —  | 158 | 954  | 15.5 | 127 | 15.5 | 245 |
| SPB1250-08 | 8             | 1250.0 | 1257.0 | 5    | 5050     | 125      | —  | 158 | 1204 | 15.5 | 127 | 15.5 | 245 |

## Taper Bore V-pulleys

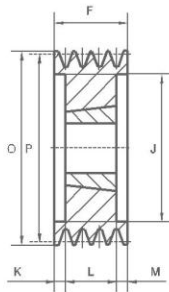

TYPE3

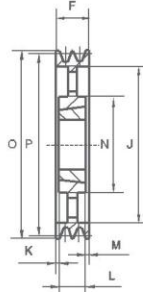

TYPE5

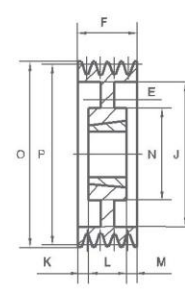

TYPE6

# SPB-10

| ITEM NO.   | NO.OF GROOVES | P.D    | O.D    | TYPE | BUSH NO. | MAX BORE | E  | F   | J   | K    | L   | M    | N   |
|------------|---------------|--------|--------|------|----------|----------|----|-----|-----|------|-----|------|-----|
| SPB224-10  | 10            | 224.0  | 231.0  | 3    | 3535     | 90       | —  | 196 | 181 | 53.5 | 89  | 53.5 | —   |
| SPB236-10  | 10            | 236.0  | 243.0  | 3    | 3535     | 90       | —  | 196 | 193 | 53.5 | 89  | 53.5 | —   |
| SPB250-10  | 10            | 250.0  | 257.0  | 3    | 3535     | 90       | —  | 196 | 207 | 53.5 | 89  | 53.5 | —   |
| SPB280-10  | 10            | 280.0  | 287.0  | 3    | 3535     | 90       | —  | 196 | 237 | 53.5 | 89  | 53.5 | —   |
| SPB315-10  | 10            | 315.0  | 322.0  | 6    | 3535     | 90       | 18 | 196 | 272 | 53.5 | 89  | 53.5 | 170 |
| SPB335-10  | 10            | 335.0  | 342.0  | 6    | 4040     | 100      | 20 | 196 | 292 | 47   | 102 | 47   | 200 |
| SPB355-10  | 10            | 355.0  | 362.0  | 6    | 4040     | 100      | 20 | 196 | 312 | 47   | 102 | 47   | 200 |
| SPB400-10  | 10            | 400.0  | 407.0  | 5    | 4040     | 100      | —  | 196 | 357 | 47   | 102 | 47   | 200 |
| SPB450-10  | 10            | 450.0  | 457.0  | 5    | 4545     | 110      | —  | 196 | 407 | 41   | 114 | 41   | 225 |
| SPB500-10  | 10            | 500.0  | 507.0  | 5    | 4545     | 110      | —  | 196 | 457 | 41   | 114 | 41   | 225 |
| SPB560-10  | 10            | 560.0  | 567.0  | 5    | 4545     | 110      | —  | 196 | 517 | 41   | 114 | 41   | 225 |
| SPB630-10  | 10            | 630.0  | 637.0  | 5    | 4545     | 110      | —  | 196 | 587 | 41   | 114 | 41   | 225 |
| SPB710-10  | 10            | 710.0  | 717.0  | 5    | 4545     | 110      | —  | 196 | 664 | 41   | 114 | 41   | 225 |
| SPB800-10  | 10            | 800.0  | 807.0  | 5    | 4545     | 110      | —  | 196 | 754 | 41   | 114 | 41   | 225 |
| SPB900-10  | 10            | 900.0  | 907.0  | 5    | 5050     | 125      | —  | 196 | 854 | 34.5 | 127 | 34.5 | 245 |
| SPB1000-10 | 10            | 1000.0 | 1007.0 | 5    | 5050     | 125      | —  | 196 | 954 | 34.5 | 127 | 34.5 | 245 |

### Standard bore dimensions of taper bore bushes

| Bushing | Stock Bores |    |    |    |    |    |    |    |    |    |    |    |    |    |    |    |    |    |    |    |     |     |     |     |     |   |
|---------|-------------|----|----|----|----|----|----|----|----|----|----|----|----|----|----|----|----|----|----|----|-----|-----|-----|-----|-----|---|
|         | 25          | 28 | 30 | 32 | 35 | 38 | 40 | 42 | 45 | 48 | 50 | 55 | 60 | 65 | 70 | 75 | 80 | 85 | 90 | 95 | 100 | 105 | 115 | 120 | 125 |   |
| 3030    | ●           | ●  | ●  | ●  | ●  | ●  | ●  | ●  | ●  | ●  | ●  | ●  | ●  | ●  | ●  | ●  |    |    |    |    |     |     |     |     |     |   |
| 3535    |             |    |    |    | ●  | ●  | ●  | ●  | ●  | ●  | ●  | ●  | ●  | ●  | ●  | ●  | ●  | ●  | ●  |    |     |     |     |     |     |   |
| 4040    |             |    |    |    |    |    |    | ●  | ●  | ●  | ●  | ●  | ●  | ●  | ●  | ●  | ●  | ●  | ●  | ●  | ●   | ●   |     |     |     |   |
| 4045    |             |    |    |    |    |    |    |    |    |    |    | ●  | ●  | ●  | ●  | ●  | ●  | ●  | ●  | ●  | ●   | ●   | ●   |     |     |   |
| 5050    |             |    |    |    |    |    |    |    |    |    |    |    | ●  | ●  | ●  | ●  | ●  | ●  | ●  | ●  | ●   | ●   | ●   | ●   | ●   | ● |